

**SINGER**  
**111W152**

*© Watson*

Form 2655w

( 940 )

Printed in U. S. A.

# LIST OF PARTS



MACHINE No. III w 152

\*\*\* A TRADE-MARK OF

THE SINGER MANUFACTURING COMPANY

# INSTRUCTIONS FOR OILING

To ensure easy running and prevent unnecessary wear of the parts which are in movable contact, the machine requires oiling and when in continuous use, "TYPE B" or "TYPE D" OIL, sold only by Singer Sewing Machine Company, should be applied at least twice each day to all oil holes marked "OIL", as instructed in Form 2663w.

"TYPE D" OIL is stainless.

## INDEX

	Page
Accessories .....	14
Bobbin Winder .....	14
Feed Dogs .....	16
Foot Lifter .....	17
Knee Lifter .....	15
Machine No. 1111w152 .....	5
Miscellaneous Parts .....	18
Numerical List of Parts .....	19
Presser Feet .....	16
Thread Unwinder .....	18
Throat Plates .....	17

From the library of: Diamond Needle Corp

Copyright, U. S. A., 1938, 1939 and 1940  
by The Singer Manufacturing Co.  
All Rights Reserved for all Countries

# INSTRUCTIONS FOR ORDERING

In ordering from this list, use ONLY the PART number in the FIRST column.

The number stamped on a Sewing Machine Part is the number of the Single Part only, except when the part includes Set Screws, Clamping Screws, Studs and Rollers Spun on, Small Wires riveted, or Parts soldered together, etc., which it is necessary to furnish in combination.

Every combination of parts sent out has its specific number which, although not stamped on Parts (except in above case), must be used when ordering the combination.

Each number always indicates the SAME PART in whatever list it appears, or for whatever Machine.

The letters after some of the numbers indicate the style of finish only, as follows:

- A. Hardened, Polished, Nickel Plated and Buffed.
- B. Polished, Nickel Plated and Buffed.
- C. Hardened only.
- D. Polished only.
- E. Soft, not polished.
- F. Hardened and Polished.
- H. Blued.
- J. Nickel Plated only.
- R. Merlized.
- X. Black Oxide.
- XC. Hardened and Black Oxide.
- Y. Blade Nickel only.

These letters MUST BE USED when they appear in the list and AFTER the number, as in the list.

In this series:  
 200001 to 201500 and 350001 to 351500 are Screw Numbers.  
 201501 to 201800 and 351501 to 351800 are Nut Numbers.  
 201801 to 202000 and 351801 to 352000 are Roller Numbers.  
 202001 to 350000 are Numbers of Machine Parts.

The figures in the second column refer only to the plate in which the illustration of the part is shown and are NOT TO BE USED in ordering.

Two or more numbers over a cut indicate that the difference between such parts is not visible in an illustration.

Parts marked with an asterisk (\*) are furnished when repairs are made at the factory.

## LIST OF PARTS COMPLETE FOR

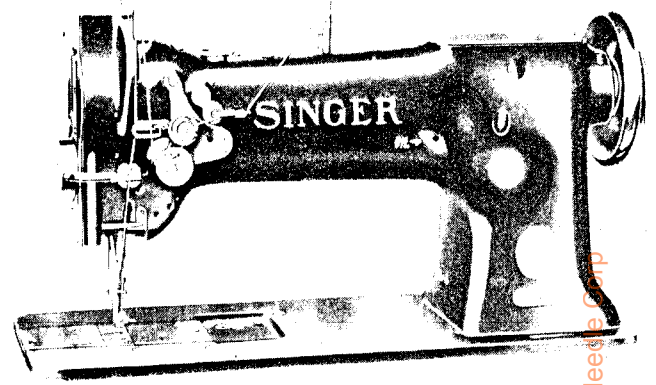

### MACHINE No. IIIw152

- HIGH SPEED. KNEE LIFTER.
- COMPOUND FEED. ALTERNATING PRESSERS.
- POSITIVE STITCH REGULATION.
- SAFETY CLUTCH.

For Leather Gloves, Combination Leather and Canvas Gloves, etc.

No.	Plate	Name
*240501	-----	Arm with 202135
224002	16624	" Cap
200278H	16624	" " Screw
202248	16624	" " " Washer
204235	16630	" Position Pin (2)
200004E	16630	" Screw (3)
202005	16630	" " Washer (3)
240502	16624	" Shaft with 224392 and 350431E
240802	16624	" " Bushing (back) with 202244
202244	16624	" " " " Oil Packing (wick)
200338C	16624	" " " " Set Screw
263096	16624	" " " (front) with 223847
223847	16624	" " " " Oil Packing (wick)
200502B	16624	" " " " " " Thumb Screw

From the library of: Diamond Needle Corp

No.	Plate	Name
204329	16624	Arm Shaft Bushing (front) Oil Pad
200338C	16624	" " " " Set Screw
224103	16604	" " Connection Belt
224104	16604	" " " " Pulley with 200327C, 200602E and two 202253
200602E	16604	Arm Shaft Connection Belt Pulley Position Screw
200327C	16604	Arm Shaft Connection Belt Pulley Set Screw
202253	16604	Arm Shaft Connection Belt Pulley Spring Flange
224113	16633	Arm Shaft Connection Belt Timing Collar with 200113F
200113F	16633	Arm Shaft Connection Belt Timing Collar Set Screw
224139	16633	Arm Shaft Connection Belt Timing Plate
200164B	16633	" " " " " " " Screw (2)
224392	16624	Arm Shaft Oil Packing (wick)
350431E	16624	" " " " Stop Screw
237202	16624	Balance Wheel (disc) 5-1/4 in.diam. (belt groove 2-3/4 in.diam.) with 200328C and 200335C
350419H	16624	Balance Wheel Adjusting Screw
200328C	16624	" " Position Screw
200335C	16624	" " Set Screw
*240222	-----	Bed
255168	16633	" Oil Cup (4)
240003	16630	" Slide (back)
223811	16630	" " " Stop
223812	16630	" " " Spring
240004	16630	" " (front)
203470	16625	Bobbin
*235099	-----	" Case
203648	16625	" " Latch
*202056	-----	" " Pin
203473	16625	" " Plunger
203474	16625	" " Spring
241674	16625	" " Oiling Felt
241675	16625	" " " Retainer
350405C	16625	" " " " Screw
224004	16626	" " Opener
224005	16626	" " Lever with 201349C, 201542C and 203101
201349C	16626	Bobbin Case Opener Lever Driving Screw Stud
201542C	16626	Bobbin Case Opener Lever Driving Screw Stud Nut

No.	Plate	Name
203101	16626	Bobbin Case Opener Lever Driving Screw Stud Oil Packing (wick)
265088	16626	Bobbin Case Opener Lever Hinge Stud with 202277
202277	16626	Bobbin Case Opener Lever Hinge Stud Oil Packing (wick)
200364C	16626	Bobbin Case Opener Lever Hinge Stud Set Screw
223623	16626	Bobbin Case Opener Lever Link
200119D	16626	" " " Screw
202214	16625	" " Tension Spring
200984C	16625	" " " " Regulating Screw
200594C	16625	Bobbin Case Tension Spring Screw
202216	16625	" " Washer (cloth)
235100	16625	Bobbin Case complete, Nos. 200594C, 200984C, 202056, 203214, 203216, 203473, 203474, 203643, 235099, 241674, 241675 and two 350405C
240179	16630	Face Plate with 201650H and 350432XC
202135	16630	" " Position Pin
200473B	16630	" " Thumb Screw
240223	16627	Feed Bar
240224	16627	" " 240223 with 224052, 225837 and 350197E
350393C	16627	Feed Bar Hinge Screw (driving)
201518E	16627	" " " " Nut
240116	16627	" Dog, 46 needle hole, for needle sizes 16 and 18
200106E	16627	Feed Dog Screw (2)
240225	16633	" Driving Connection with 240226 and 240227
201181C	16633	Feed Driving Connection Hinge Screw
201518E	16633	" " " " Nut
240226	16633	" " " Oiling Felt
240227	16633	" " " " Retain- ing Wire
240228	16627	Feed Driving Crank with 200019E
200019E	16627	" " " Pinch Screw
240229	16633	" " Eccentric
240230	16633	" " " Adjusting Disc
248415	16633	" " " " Spring
248416	16633	" " " " " " Collar with two 200332C
200332C	16633	Feed Driving Eccentric Adjusting Disc Spring Collar Set Screw
240231	16633	Feed Driving Eccentric Friction Gib
200369C	16633	" " " " " " Ad- justing Screw

No.	Plate	Name
350101C	16633	Feed Driving Eccentric Friction Gib Adjusting Screw Set Screw
240232	16633	Feed Driving Flange with 200333C, 200346C two each 200369C and 350101C
200333C	16633	Feed Driving Flange Position Screw
200346C	16633	" " " " Set Screw
223650	16627	" " " " Rock Shaft
240233	16627	" " " " 223650 with 201518E, 240224 and 350393C
223652	16627	Feed Driving Rock Shaft Crank with 200019E
200019E	16627	Feed Driving Rock Shaft Crank Pinch Screw
202625	16627	" " " " Stop Collar with two 200383C (2)
200383C	16627	Feed Driving Rock Shaft Stop Collar Set Screw
248449	16604	Feed Indicating Disc with 200958C
200958C	16604	" " " " Set Screw
224154	16633	" Lifting Cam with 201220C
224052	16627	" " " " Fork with 200173D and 223655
350197E	16627	Feed Lifting Cam Fork Screw
225837	16627	" " " " Washer
223655	16627	" " " " Oiling Felt
200173D	16627	" " " " " Screw
201220C	16633	" " " " Set Screw
240235	16633	" Regulating Stud
240245	16633	" " " " Retaining Spring
248425	16633	" " " " Spring
*240162	-----	Hook (sewing)
240163	16625	" 240162 with 203525, 224025, two each 200590H and 201253F
240211	16625	Hook and Bobbin Case complete, Nos. 235100 and 240163
224019	16626	Hook Bushing (lower) (bronze)
200364C	16626	" " " " Set Screw
224020	16626	" " (upper) (bronze)
200446C	16626	" " " " Position Screw
223867	16633	" Driving Gear (spiral) with 200362C and 201222C
201222C	16633	Hook Driving Gear Position Screw
200362C	16633	" " " " Set Screw
240167	16626	" " Pinion (spiral) with 200382C and 201220C
201220C	16626	Hook Driving Pinion Position Screw
200382C	16626	" " " " Set Screw
224022	16626	" " " " Thrust Washer
240241	16633	" " " " Shaft

No.	Plate	Name
224111	16633	Hook Driving Shaft Bushing (back) with 202244
202244	16633	Hook Driving Shaft Bushing (back) Oil Packing (wick)
237529	16633	Hook Driving Shaft Bushing (front)
200327C	16633	" " " " " Set Screw (2)
265314	16633	" " " " Lock Ratchet with 200354C and 200362C
200354C	16633	Hook Driving Shaft Lock Ratchet Position Screw
200362C	16633	Hook Driving Shaft Lock Ratchet Set Screw
240244	16633	" " " " Stud
240245	16633	" " " " Retaining Spring
248425	16633	Hook Driving Shaft Lock Stud Spring
203525	16625	" Gib
201253F	16625	" " Screw
223850	16626	" Saddle with 200009E
224024	16626	" " 223850 with 200364C, 200446C, 224019 and 224020
240243	16633	Hook Saddle Bearing
200335C	16633	" " " " Set Screw
200009E	16626	" " Pinch Screw
200006E	16626	" " Screw
225585	16626	" " " Washer
240165	16626	Hook Saddle complete, Nos. 200118D, 200364C, 223623, 224004, 224005, 224022, 224024, 240167, 240211 and 265088
224025	16625	Hook Washer
200590H	16625	" " " Screw
237837	16630	Knee Lifter Connection Lever
200262H	16630	" " " " Hinge Screw
223684	16630	" " " " Lifting Rod with 202302
202302	16630	Knee Lifter Connection Lever Lifting Rod Cotter Pin
206628	16630	Knee Lifter Connection Lever Lifting Rod Spring
227227	16630	Knee Lifter Connection Lever Lifting Rod Spring Collar with 200113F
200113F	16630	Knee Lifter Connection Lever Lifting Rod Spring Collar Set Screw
240175	16630	Knee Lifter Lifting Lever
200262H	16630	" " " " Hinge Screw
240205	16629	Lifting Bell Crank
200996C	16629	" " " " Cap Screw
240125	16246	" " " " Link
350172C	16246	" " " " Screw Stud

From the library: Diamond Needle Corp.

No.	Plate	Name
201524E	16246	Lifting Bell Crank Link Screw Stud Nut
240160	16246	" Eccentric with 200382C and 200383C
240126	16246	" " Connection
240171	16246	" " " Crank with 200029E and 248821
248821	16246	Lifting Eccentric Connection Crank Oil Packing (wick)
200029E	16246	Lifting Eccentric Connection Crank Pinch Screw
200398C	16246	Lifting Eccentric Position Screw
200382C	16246	" " Set Screw
240133	16629	" Presser Foot
200074F	16629	" " " Screw
240136	16246	" Rock Shaft with 201524E and 350172C
240174	16246	Lifting Rock Shaft Bushing (2)
240219	16628	Needle Bar with 200125F, 200175D and 240170
202552	16628	Needle Bar Connecting Link
264718	16628	" " " " Oil Guard
200161D	16628	" " " " " Screw
202333	16628	" " " " Stud with 202254
202254	16628	Needle Bar Connecting Link Stud Oil Pack- ing (wick)
200374C	16628	Needle Bar Connecting Link Stud Set Screw
200383C	16628	" " " " " " "
208552	16628	" " " Stud with 200038C and 200370
200330	16628	Needle Bar Connecting Stud Oil Packing (wick)
200086C	16628	Needle Bar Connecting Stud Pinch Screw
202692	16628	" " Crank with 200335C, 200374C, 200383C, 200428C and 202373
240137	16628	Needle Bar Crank 202692 with 200399, 202400, 202552, 208552 and 240139
203172	16628	Needle Bar Crank Friction Washer
200428C	16628	" " " Position Screw
200335C	16628	" " " Set Screw
240508	16628	" " Rock Frame
248437	16628	" " " " Hinge Stud
200347C	16628	" " " " " " Set Screw
202666	16628	" " " " Position Bracket
200098F	16628	" " " " " " Screw
223690	16246	" " " " Rock Shaft
223691	16246	" " " " " " 223690 with 200387C and 210920
223692	16246	Needle Bar Rock Frame Rock Shaft Crank with 200029E

No.	Plate	Name
222693	16604	Needle Bar Rock Frame Rock Shaft Crank Connection with 202277
201407C	16604	Needle Bar Rock Frame Rock Shaft Crank Connection Hinge Screw (lower)
206758	16604	Needle Bar Rock Frame Rock Shaft Crank Connection Hinge Screw (lower) Oil Packing (wick)
201517E	16604	Needle Bar Rock Frame Rock Shaft Crank Connection Hinge Screw (lower) Nut
200333C	16604	Needle Bar Rock Frame Rock Shaft Crank Connection Hinge Screw (upper)
201522E	16604	Needle Bar Rock Frame Rock Shaft Crank Connection Hinge Screw (upper) Nut
202277	16604	Needle Bar Rock Frame Rock Shaft Crank Connection Oil Packing (wick)
200029E	16246	Needle Bar Rock Frame Rock Shaft Crank Pinch Screw
202668	16246	Needle Bar Rock Frame Slide Block
210920	16246	" " " " " " 202668 with 201141C
201141C	16246	Needle Bar Rock Frame Slide Block Stud
200387C	16246	" " " " " " " Set Screw
240170	16628	Needle Bar Thread Guide
200175D	16628	" " " " " Screw
200125F	16628	" Set Screw
208566	16629	Presser Bar with 200074F
241535	16629	" " Bushing
207072	16629	" " " (upper)
200352C	16629	" " " Set Screw (2)
202554	16629	" " Lifter
200653C	16629	" " " Hinge Screw
208555	16629	" " Lifting Bracket with 200054E
200975F	16629	" " " " Guide Screw
200054E	16629	" " " " Pinch Screw
202337	16629	" " Position Guide
202338	16629	" " " " Lever with 200086F
200086F	16629	Presser Bar Position Guide Lever Pinch Screw
200352C	16629	Presser Bar Position Guide Set Screw
237836	16630	" " Spring (flat)
210949	16629	" " " Bracket with 200086C
200086C	16629	" " " " Pinch Screw
201410F	16630	" " " Regulating Screw
200948F	16630	" " " Support Screw
265032	16633	Safety Clutch Hook Driving Shaft Position Collar with two 201254C

No.	Plate	Name
201254C	16633	Safety Clutch Hook Driving Shaft Position Collar Set Screw
265101	16633	Safety Clutch Locking Lever
265050	16633	" " " " Connecting Link
350433C	16633	" " " " Hinge Screw
265102	16633	" " " " Spring
350436C	16633	" " " " Screw
265103	16633	" " Pulley with 202253
202253	16633	" " Spring Flange
265057	16633	" " Throw-in Latch
265052	16633	" " " " Pin
265051	16633	" " " " Spring
265104	16633	Safety Clutch complete, Nos. 265032, 265050 to 265052, 265057, 265101 to 265103, 350433C and 350436C
240139	16628	Take-up Lever
202399	16628	" " Driving Stud with 202277
202277	16628	" " " " Oil Packing (wick)
202400	16628	Take-up Lever Hinge Stud with 202423
202423	16628	" " " " Oil Packing (wick)
200363C	16628	Take-up Lever Hinge Stud Set Screw
240023	16620	Tension Bracket with 201224B and 236060
200159F	16620	" " Screw
240446	16620	Tension Bracket complete, Nos. 200978H, 201199F, 204271, 223438, 223703, 223704, 223706, 237174, 240023, two each 200309E, 201572B and 244048
244048	16620	Tension Disc
236060	16620	" " Position Pin
223703	16620	" Release Lever
235576	16629	" " Rod
200309E	16620	" " Screw
223704	16620	" " Plunger
240141	16629	" " Slide
240142	16629	" " Spring
204271	16620	" " Washer
223438	16620	" Spring
201224B	16620	" Stud
201572B	16620	" Thumb Nut
223706	16620	Thread Controller Disc
200978H	16620	" " Screw
237174	16620	" " Spring
241360	16620	" " Stop
200132E	16620	" " Screw
201199F	16620	" " Stud with 204925
200061C	16620	" " Set Screw

No.	Plate	Name
201572B	16620	Thread Controller Stud Thumb Nut
204925	16620	" " " Washer
202412	16624	" Guide
224040	16620	" " "
210955	16620	" " (upper)
200582H	16620	" " Screw (3)
241755	16630	" Lubricator Oil Pad (felt)
237845	16630	" " " Holder
240439	16630	" " " Retainer
241758	16630	" " Reservoir
241759	16630	" " Wick
350432XC	16630	" " Screw
201650H	16630	" " Nut
214838	16630	" " Washer
237846	16630	Thread Lubricator complete, Nos. 214838, 237845, 240439, 241755, 241758 and 241759
240034	16620	Thread Retainer
200355H	16620	" " Set Screw
240145	16630	Throat Plate
691F	16630	" " Screw (2)
240183	16629	Vibrating Presser Bar
240184	16629	" " Connecting Link
240185	16629	" " Extension with 204264 and 240186
240186	16629	Vibrating Presser Bar Extension Collar
204264	16629	" " " " Pin
202277	16629	" " Oil Packing (wick)
240188	16629	" " Spring
350299C	16629	" " Thumb Screw (pressure regulating)
240153	16629	Vibrating Presser Foot, 40 needle hole, with 201015F
201015F	16629	Vibrating Presser Foot Pinch Screw



## ACCESSORIES

No.	Plate	Name
200157B	16630	Attachment Screw
200861D	16630	Bed Slide (back) Locking Thumb Screw
203470	16625	Bobbin (5)
*225482	-----	" Case Screw Driver Blade
*225483	-----	" " " " Handle
225497	17620	Bobbin Case Screw Driver complete, Nos. 225482 and 225483
231337	16630	Cloth Guide
200861D	16630	" " Thumb Screw
135 x 17	16628	Needles, six, size 18
224121	16644	Drip Pan, 20 in. long, with four 1 in. wire nails
12361	16630	Machine Hinge Connection (2)
41400	17620	" Rest Pin (wood)
120342	17620	Oiler (copper plated) with 120343
120343	17620	" Spout, 3-1/2 in. long
225498	17620	Screw Driver (7-1/4 in. long)
225554	17620	Wrench (steel)

## BOBBIN WINDER

(SWINGING AUTOMATIC, RIGHT HAND)

259428	16615	Brake (leather)
259429	16615	" Clamp
200113F	16615	" " Screw
225453	16615	Frame with 202277 and 225438
225454	16615	" Hinge Pin
202277	16615	" Oil Packing (wick)
225438	16615	" " Well Cap
225455	16615	" Spring
225456	16615	" " Plunger
225368	16615	Pulley with 200380C
200380C	16615	" Set Screw
225381	16615	Spindle
225444	16615	Stop Latch
200056E	16615	" " Screw
225458	16615	" " Thumb Lever
225459	16615	" " " " Hinge Stud
225459	16615	" " " " Joint Stud
202478	16615	" " Trip Lever

No.	Plate	Name
200299H	16615	Stop Latch Trip Lever Hinge Screw
225461	16615	Tension Bracket with 201499B
200082D	16615	" " Screw
225026	16615	" " " Washer
2102	16615	" Disc
12710	16615	" Spring
201499B	16615	" Stud
201572E	16615	" " Thumb Nut
225462	16615	Bobbin Winder Tension Bracket complete, Nos. 12710, 201572E, 225461 and two 2102
210430	16615	Bobbin Winder and Tension Bracket Base
210431	16615	Universal Bobbin Winder complete, Nos. 200056E, 200082D, 200113F, 200299H, 202478, 225368, 225381, 225444, 225453 to 225456, 225458, 225462, 225026, 259428 to 259430, two each 225459 and wood screws 3/4 in., No. 12, R.H.B.

## KNEE LIFTER

228359	16643	Rock Lever with two 350231C
228360	16643	" " Bracket with 200347C and three wood screws 7/8 in., No. 12
228361	16643	Rock Lever Bracket 228360 with 228359, 228362, 228367 and 228386
228362	16643	Rock Lever Extension with 200529C
350231C	16643	" " " Set Screw
228363	16643	" " Hinge Pin
228364	16643	" " Knee Plate with 350231C
228369	16643	" " " " Arm
350231C	16643	" " " " " Set Screw
350231C	16643	" " " " " Set Screw
228365	16643	" " Rod
200529C	16643	" " " Set Screw
228386	16643	" " Spring
228367	16643	" " Stop Stud
200347C	16643	" " " " Set Screw
228368	16643	Knee Lifter complete, Nos. 228361, 228362, 228364, 228365 and 228369

(Other Knee Lifter Parts are listed with parts of machine head.)

From the library of: Diamond Needle Co.

## FEED DOGS

No.	Plate	Name
240118	16631	Feed Dog,46 needle hole,for needle sizes 16 and 18,for 240143
240112	16631	Feed Dog,40 needle hole,for needle sizes 20 and 22,for 240144
240113	16631	Feed Dog,46 needle hole,for needle sizes 16 and 18,for 240144
240114	16631	Feed Dog,50 needle hole,for needle sizes 14 and 15,for 240144
240115	16631	Feed Dog,50 needle hole,for needle sizes 14 and 15,for 240145
240116	16631	Feed Dog,46 needle hole,for needle sizes 16 and 18,for 240145
240117	16631	Feed Dog,40 needle hole,for needle sizes 20 and 22,for 240145

## PRESSER FEET

240128	16632	Lifting Presser Foot,for closing gloves, for 240150 to 240152
240130	16632	Lifting Presser Foot,for cording and general upholstery,for 240154
240132	16632	Lifting Presser Foot,for 240156
240133	16632	" " " " 240153
240134	16632	" " " " 240157
240135	16632	" " " " cording and general upholstery,for 240158
240150	16632	Vibrating Presser Foot,38 needle hole, with 201015F,for closing gloves,for 240128
240151	16632	Vibrating Presser Foot,50 needle hole, with 201015F,for 240128
240152	16632	Vibrating Presser Foot,46 needle hole, with 201015F,for 240128
240153	16632	Vibrating Presser Foot,40 needle hole, with 201015F,for 240133
240154	16632	Vibrating Presser Foot,40 needle hole, with 201015F,for 240130
240156	16632	Vibrating Presser Foot,46 needle hole, with 201015F,for 240132

No.	Plate	Name
240157	16632	Vibrating Presser Foot,40 needle hole, with 201015F,for 240134
240158	16632	Vibrating Presser Foot,40 needle hole, with 201015F,for 240135

## THROAT PLATES

240143	16631	Throat Plate,for 240118
240144	16631	" " " 240112 to 240114
240145	16631	" " " 240115 to 240117

## FOOT LIFTER

Parts Required For Changing From  
Knee Lifter to Foot Lifter

223733	16630	Lifting Lever Extension
200082D	16630	" " " Screw (2)
227561	16630	" " Spring

## FOOT LIFTER

227952	17620	Lever (left or right) with 227954
227678	17620	" Chain,48 in.long,with 202784
227954	17620	" " Hook (lower)
202784	17620	" " " (upper)
225016	17620	" Hinge Pin
227953	17620	" Stand with two wood screws 1 in.No. 12
227955	17620	Foot Lifter Lever (left or right) complete,Nos.225016,227678,227952 and 227953

## THREAD UNWINDER

No.	Plate	Name
225257	17900	Spool Rest (for two spools) (flat) with 201018C
150203	17900	Spool Rest Cushion (felt)
225388	17900	" " Rod
200383C	17900	" " " Set Screw
201018C	17900	" " Set Screw
202490	17900	" Stand with 200383C
225391	17900	Thread Guide
201696J	17900	" " Lock Nut
225326	17900	" " Position Cup
225324	17900	" " Rod with 208E and 225322
208E	17900	" " " Screw
225322	17900	" " " Washer
225258	17900	Thread Unwinder (for two spools) complete, Nos. 201696J, 202490, 225257, 225324, 225326, 225388, two each 150203, 225391 and three wood screws 7/8 in., No. 12

## MISCELLANEOUS PARTS

60913	17900	Spool Weight with 60914
60914	17900	" " Center Pin
225377	17900	" Wire, for small spools
27739	17900	Thread Cone (wood)
225390	17900	" " Holder

**SINGER** Needles should be used  
in **SINGER** Machines  
These Needles and their Containers  
are marked with the  
Company's Trade Mark "SIMANCO."<sup>\*\*\*</sup> 1

Needles in Containers marked  
"FOR SINGER MACHINES"  
are **NOT SINGER** made needles. 2

## NUMERICAL LIST OF PARTS

No.	Plate	Name
208E	17900	Thread Unwinder Thread Guide Rod Screw, for 225324
691F	16630	Throat Plate Screw
2102	16615	Bobbin Winder Tension Disc, for 225462
12361	16630	Machine Hinge Connection
13710	16615	Bobbin Winder Tension Spring, for 225462
27739	17900	Thread Cone (wood)
41400	17620	Machine Rest Pin (wood)
60913	17900	Spool Weight with 60914
60914	17900	" " Center Pin, for 60913
120342	17620	Oiler (copper plated) with 120343
120343	17620	" Spout, 3-1/2 in. long, for 120342
150203	17900	Thread Unwinder Spool Rest Cushion (felt) for 225258
200004E	16630	Arm Screw
200006E	16626	Hook Saddle Screw
200009E	16626	" " Pinch Screw, for 223850
200019E	16627	Feed Driving Crank Pinch Screw, for 240228
200019E	16627	" " Rock Shaft Crank Pinch Screw, for 223652
200029E	16246	Lifting Eccentric Connection Crank Pinch Screw, for 240171
200029E	16246	Needle Bar Rock Frame Rock Shaft Crank Pinch Screw, for 223692
200054E	16629	Presser Bar Lifting Bracket Pinch Screw, for 208555
200056E	16615	Bobbin Winder Stop Latch Screw, for 259431
200061C	16620	Thread Controller Stud Set Screw
200074F	16629	Lifting Presser Foot Screw, for 208566
200082D	16615	Bobbin Winder Tension Bracket Screw, for 259431
200082D	16630	Foot Lifter Lifting Lever Extension Screw
200086C	16628	Needle Bar Connecting Stud Pinch Screw, for 208552
200086F	16629	Presser Bar Position Guide Lever Pinch Screw, for 202338
200086C	16629	Presser Bar Spring Bracket Pinch Screw, for 210949
200098F	16628	Needle Bar Rock Frame Position Bracket Screw
200106E	16627	Feed Dog Screw

From the library of: Diamond Needle Corp

## NUMERICAL LIST OF PARTS

No.	Plate	Name
200113F	16633	Arm Shaft Connection Belt Timing Collar Set Screw, for 224113
200113F	16615	Bobbin Winder Brake Clamp Screw, for 259431
200113F	16630	Knee Lifter Connection Lever Lifting Rod Spring Collar Set Screw, for 227227
200118D	16626	Bobbin Case Opener Screw, for 240165
200125F	16628	Needle Set Screw, for 240219
200132E	16620	Thread Controller Spring Stop Screw
200157B	16630	Attachment Screw
200159F	16620	Tension Bracket Screw
200161D	16628	Needle Bar Connecting Link Oil Guard Screw
200164D	16633	Arm Shaft Connection Belt Timing Plate Screw
200173D	16627	Feed Lifting Cam Oiling Felt Screw, for 224052
200175D	16628	Needle Bar Thread Guide Screw, for 240219
200262H	16630	Knee Lifter Connection Lever Hinge Screw
200262H	16630	" " Lifting Lever Hinge Screw
200278H	16624	Arm Cap Screw
200299H	16615	Bobbin Winder Stop Latch Trip Lever Hinge Screw, for 259431
200309E	16620	Tension Release Lever Screw, for 240446
200327C	16604	Arm Shaft Connection Belt Pulley Set Screw, for 224104
200327C	16633	Hook Driving Shaft Bushing Set Screw
200328C	16624	Balance Wheel Position Screw, for 237202
200333C	16633	Feed Driving Flange Position Screw, for 240232
200335C	16624	Balance Wheel Set Screw, for 237202
200335C	16633	Hook Saddle Bearing Set Screw
200335C	16628	Needle Bar Crank Set Screw, for 202692
200338C	16624	Arm Shaft Bushing (back) Set Screw
200338C	16624	" " " (front) Set Screw
200346C	16633	Feed Driving Flange Set Screw, for 240232
200347C	16643	Knee Lifter Rock Lever Stop Stud Set Screw, for 228360
200347C	16628	Needle Bar Rock Frame Hinge Stud Set Screw
200352C	16629	Presser Bar Bushing Set Screw
200352C	16629	" " Position Guide Set Screw
200354C	16633	Hook Driving Shaft Lock Ratchet Position Screw, for 265314
200355H	16620	Thread Retainer Set Screw
200362C	16633	Hook Driving Gear Set Screw, for 223867
200362C	16633	" " Shaft Lock Ratchet Set Screw, for 265314

## NUMERICAL LIST OF PARTS

No.	Plate	Name
200363C	16628	Take-up Lever Hinge Stud Set Screw
200364C	16626	Bobbin Case Opener Lever Hinge Stud Set Screw, for 240165
200364C	16626	Hook Bushing (lower) Set Screw, for 224024
200369C	16633	Feed Driving Eccentric Friction G1b Adjusting Screw, for 240232
200374C	16628	Needle Bar Connecting Link Stud Set Screw, for 202692
200380C	16615	Bobbin Winder Pulley Set Screw, for 225368
200382C	16633	Feed Driving Eccentric Adjusting Disc Spring Collar Set Screw, for 248416
200382C	16626	Hook Driving Pinion Set Screw, for 240167
200382C	16246	Lifting Eccentric Set Screw, for 240160
200383C	16627	Feed Driving Rock Shaft Stop Collar Set Screw, for 202625
200383C	16628	Needle Bar Connecting Link Stud Set Screw, for 202692
200383C	17900	Thread Unwinder Spool Rest Rod Set Screw, for 202490
200387C	16246	Needle Bar Rock Frame Slide Block Stud Set Screw, for 223691
200398C	16246	Lifting Eccentric Position Screw, for 240160
200428C	16628	Needle Bar Crank Position Screw, for 202692
200446C	16626	Hook Bushing (upper) Position Screw, for 224024
200473B	16630	Face Plate Thumb Screw
200502B	16624	Arm Shaft Bushing (front) Oil Packing Thumb Screw
200529C	16643	Knee Lifter Rock Lever Rod Set Screw, for 228362
200582H	16620	Thread Guide Screw
200590H	16625	Hook Washer Screw, for 240163
200594C	16625	Bobbin Case Tension Spring Screw, for 235100
200602E	16604	Arm Shaft Connection Belt Pulley Position Screw, for 224104
200653C	16629	Presser Bar Lifter Hinge Screw
200832C	16604	Needle Bar Rock Frame Rock Shaft Crank Connection Hinge Screw (upper)
200861D	16630	Bed Slide (back) Locking Thumb Screw
200861D	16630	Cloth Guide Thumb Screw
200948F	16630	Presser Bar Spring Support Screw
200958C	16604	Feed Indicating Disc Set Screw, for 248449
200975F	16629	Presser Bar Lifting Bracket Guide Screw
200978H	16620	Thread Controller Disc Screw, for 240446
200984C	16625	Bobbin Case Tension Spring Regulating Screw, for 235100

## NUMERICAL LIST OF PARTS

No.	Plate	Name
200996C	16629	Lifting Bell Crank Cap Screw
201015F	16629	Vibrating Presser Foot Pinch Screw, for 240150 to 240154 and 240156 to 240158
201018C	17900	Thread Unwinder Spool Rest Set Screw, for 225257
201141C	16246	Needle Bar Rock Frame Slide Block Stud, for 210920
201181C	16633	Feed Driving Connection Hinge Screw
201199F	16620	Thread Controller Stud with 204925, for 240446
201220C	16633	Feed Lifting Cam Set Screw, for 224154
201220C	16626	Hook Driving Pinion Position Screw, for 240167
201222C	16633	Hook Driving Gear Position Screw, for 223867
201224B	16620	Tension Stud, for 240023
201253F	16625	Hook Gib Screw, for 240163
201254C	16633	Safety Clutch Hook Driving Shaft Posi- tion Collar Set Screw, for 265032
201349C	16626	Bobbin Case Opener Lever Driving Screw Stud, for 224005
201407C	16604	Needle Bar Rock Frame Rock Shaft Crank Connection Hinge Screw (lower)
201410F	16630	Presser Bar Spring Regulating Screw
201499B	16615	Bobbin Winder Tension Stud, for 225461
201517E	16604	Needle Bar Rock Frame Rock Shaft Crank Connection Hinge Screw (lower) Nut
201518E	16627	Feed Bar Hinge Screw Nut, for 240233
201518E	16633	" Driving Connection Hinge Screw Nut
201522E	16604	Needle Bar Rock Frame Rock Shaft Crank Connection Hinge Screw (upper) Nut
201524E	16246	Lifting Bell Crank Link Screw Stud Nut for 240136
201542C	16626	Bobbin Case Opener Lever Driving Screw Stud Nut, for 224005
201572B	16615	Bobbin Winder Tension Stud Thumb Nut, for 225462
201572B	16620	Tension Thumb Nut, for 240446
201572B	16620	Thread Controller Stud Thumb Nut, for 240446
201650H	16630	Thread Lubricator Screw Nut, for 240179
201696J	17900	" Unwinder Thread Guide Lock Nut, for 225258
202005	16630	Arm Screw Washer
*202056	-----	Bobbin Case Latch Pin, for 235100
202135	16630	Face Plate Position Pin, for 240501
202244	16624	Arm Shaft Bushing (back) Oil Packing (wick), for 240802

## NUMERICAL LIST OF PARTS

No.	Plate	Name
202244	16633	Hook Driving Shaft Bushing (back) Oil Packing (wick), for 224111
202246	16624	Arm Cap Screw Washer
202253	16604	" Shaft Connection Belt Pulley Spring Flange, for 224104
202253	16633	Safety Clutch Pulley Spring Flange, for 265103
202254	16628	Needle Bar Connecting Link Stud Oil Pack- ing (wick), for 202333
202277	16626	Bobbin Case Opener Lever Hinge Stud Oil Packing (wick), for 265088
202277	16615	Bobbin Winder Frame Oil Packing (wick), for 225453
202277	16604	Needle Bar Rock Frame Rock Shaft Crank Connection Oil Packing (wick), for 223693
202277	16628	Take-up Lever Driving Stud Oil Packing (wick), for 202399
202277	16629	Vibrating Presser Bar Oil Packing (wick)
202300	16630	Knee Lifter Connection Lever Lifting Rod Cotter Pin, for 223684
202330	16628	Needle Bar Connecting Stud Oil Packing (wick), for 208552
202333	16628	Needle Bar Connecting Link Stud with 202254, for 202690
202337	16629	Presser Bar Position Guide
202338	16629	" " " " Lever with 200086F
202399	16628	Take-up Lever Driving Stud with 202277, for 240137
202400	16628	Take-up Lever Hinge Stud with 202423, for 240137
202412	16624	Thread Guide
202423	16628	Take-up Lever Hinge Stud Oil Packing (wick), for 202400
202478	16615	Bobbin Winder Stop Latch Trip Lever, for 259431
202490	17900	Thread Unwinder Spool Stand with 200383C, for 225258
202552	16628	Needle Bar Connecting Link, for 240137
202554	16629	Presser Bar Lifter
202625	16627	Feed Driving Rock Shaft Stop Collar with two 200383C
202666	16628	Needle Bar Rock Frame Position Bracket
202668	16246	" " " " Slide Block, for 210920
202692	16628	Needle Bar Crank with 200335C, 200374C, 200383C, 200428C and 202333, for 240137

## NUMERICAL LIST OF PARTS

No.	Plate	Name
202784	17620	Foot Lifter Lever Chain Hook (upper),for 227678
203101	16626	Bobbin Case Opener Lever Driving Screw Stud Oil Packing (wick),for 224005
203172	16628	Needle Bar Crank Friction Washer
203214	16625	Bobbin Case Tension Spring,for 235100
203216	16625	" " Washer (cloth),for 235100
203470	16625	Bobbin
203473	16625	" Case Latch Plunger,for 235100
203474	16625	" " Spring,for 235100
203525	16625	Hook Gib,for 240163
203648	16625	Bobbin Case Latch,for 235100
204235	16630	Arm Position Pin
204264	16629	Vibrating Presser Bar Extension Collar Pin,for 240185
204271	16620	Tension Release Washer,for 240446
204329	16624	Arm Shaft Bushing (front) Oil Pad
204925	16620	Thread Controller Stud Washer,for 201199F
206628	16630	Knee Lifter Connection Lever Lifting Rod Spring
206758	16604	Needle Bar Rock Frame Rock Shaft Crank Connection Hinge Screw (lower) Oil Packing (wick)
207072	16629	Presser Bar Bushing (upper)
208552	16628	Needle Bar Connecting Stud with 200086C and 202330,for 240137
208555	16629	Presser Bar Lifting Bracket with 200054E
208566	16629	" " with 200074F
210920	16246	Needle Bar Rock Frame Slide Block 202668 with 201141C,for 223691
210949	16629	Presser Bar Spring Bracket with 200086C
210955	16620	Thread Guide (upper)
214838	16630	" Lubricator Screw Washer,for 237846
223438	16620	Tension Spring,for 240446
223623	16626	Bobbin Case Opener Lever Link,for 240165
223650	16627	Feed Driving Rock Shaft,for 240233
223652	16627	" " " " Crank with 200019E
223655	16627	" Lifting Cam Oiling Felt,for 224052
223684	16630	Knee Lifter Connection Lever Lifting Rod with 202302
223690	16246	Needle Bar Rock Frame Rock Shaft,for 223691
223691	16246	Needle Bar Rock Frame Rock Shaft 223690 with 200387C and 210920
223692	16246	Needle Bar Rock Frame Rock Shaft Crank with 200029E
223693	16604	Needle Bar Rock Frame Rock Shaft Crank Connection with 202277
223703	16620	Tension Release Lever,for 240446

## NUMERICAL LIST OF PARTS

No.	Plate	Name
223704	16620	Tension Release Plunger,for 240446
223706	16620	Thread Controller Disc,for 240446
223733	16630	Foot Lifter Lifting Lever Extension
223811	16630	Bed Slide (back) Stop
223812	16630	" " " " Spring
223847	16624	Arm Shaft Bushing (front) Oil Packing, (wick),for 263096
223850	16626	Hook Saddle with 200009E,for 224024
223867	16633	" Driving Gear (spiral) with 200362C and 201222C
224002	16624	Arm Cap
224004	16626	Bobbin Case Opener,for 240165
224005	16626	" " " Lever with 201349C, 201542C and 203101,for 240165
224019	16626	Hook Bushing (lower) (bronze),for 224024
224020	16626	" " (upper) (bronze),for 224024
224022	16626	" Driving Pinion Thrust Washer,for 240165
224024	16626	Hook Saddle 223850 with 200364C,200446C, 224019 and 224020,for 240165
224025	16625	Hook Washer,for 240163
224040	16620	Thread Guide
224052	16627	Feed Lifting Cam Fork with 200173D and 223655,for 240224
224103	16604	Arm Shaft Connection Belt
224104	16604	" " " " Pulley with 200327C,200602E and two 202253
224111	16633	Hook Driving Shaft Bushing (back) with 202244
224113	16633	Arm Shaft Connection Belt Timing Collar with 200113F
224121	16644	Drip Pan,20 in.long,with four 1 in.wire nails
224139	16633	Arm Shaft Connection Belt Timing Plate
224154	16633	Feed Lifting Cam with 201220C
224392	16624	Arm Shaft Oil Packing (wick),for 240502
225016	17620	Foot Lifter Lever Hinge Pin,for 227955
225257	17900	Thread Unwinder Spool Rest (for two spools) (flat) with 201018C,for 225258
225258	17900	Thread Unwinder (for two spools) complete, Nos.201696J,202490,225257,225324, 225326,225388,two each 150203,225391 and three wood screws 7/8 in.,No.12
225322	17900	Thread Unwinder Thread Guide Rod Washer, for 225324
225324	17900	Thread Unwinder Thread Guide Rod with 208E and 225322,for 225258

## NUMERICAL LIST OF PARTS

No.	Plate	Name
225326	17900	Thread Unwinder Thread Guide Position Cup, for 225258
225368	16615	Bobbin Winder Pulley with 200380C, for 259431
225377	17900	Spool Wire, for small spools
225381	16615	Bobbin Winder Spindle, for 259431
225388	17900	Thread Unwinder Spool Rest Rod, for 225258
225390	17900	" Cone Holder
225391	17900	" Unwinder Thread Guide, for 225258
225438	16615	Bobbin Winder Frame Oil Well Cap, for 225453
225444	16615	Bobbin Winder Stop Latch, for 259431 Nos. 225453 to 225456, for 259431
225453	16615	Bobbin Winder Frame with 202277 and 225438
225454	16615	Bobbin Winder Frame Hinge Pin
225455	16615	" " " Spring
225456	16615	" " " Plunger
225458	16615	" " Stop Latch Thumb Lever, for 259431
225459	16615	Bobbin Winder Stop Latch Thumb Lever Hinge Stud, for 259431
225459	16615	Bobbin Winder Stop Latch Thumb Lever Joint Stud, for 259431
225461	16615	Bobbin Winder Tension Bracket with 201499B, for 225462
225462	16615	Bobbin Winder Tension Bracket complete, Nos. 13710, 201572B, 225461 and two 2102, for 259431
*225482	-----	Bobbin Case Screw Driver Blade, for 225497
*225483	-----	" " " " Handle, for 225497
225497	17620	Bobbin Case Screw Driver complete, Nos. 225482 and 225483
225498	17620	Screw Driver (7-1/4 in. long)
225554	17620	Wrench (steel)
225585	16626	Hook Saddle Screw Washer
225837	16627	Feed Lifting Cam Fork Screw Washer, for 240224
227227	16630	Knee Lifter Connection Lever Lifting Rod Spring Collar with 200113F
227561	16630	Foot Lifter Lifting Lever Spring
227678	17620	" " Lever Chain, 48 in. long, with 202784, for 227955
227952	17620	Foot Lifter Lever (left or right) with 227954, for 227955
227953	17620	Foot Lifter Lever Stand with two wood screws 1 in., No. 12, for 227955
227954	17620	Foot Lifter Lever Chain Hook (lower), for 227953

## NUMERICAL LIST OF PARTS

No.	Plate	Name
227955	17620	Foot Lifter Lever (left or right) complete, Nos. 225016, 227678, 227952 and 227953
228026	16615	Bobbin Winder Tension Bracket Screw Washer, for 259431
228359	16643	Knee Lifter Rock Lever with two 350231C, for 228361
228360	16643	Knee Lifter Rock Lever Bracket with 200547C and three wood screws 7/8 in., No. 12, for 228361
228361	16643	Knee Lifter Rock Lever Bracket 228360 with 228359, 228363, 228367 and 228386, for 228368
228362	16643	Knee Lifter Rock Lever Extension with 200529C, for 228368
228363	16643	Knee Lifter Rock Lever Hinge Pin, for 228361
228364	16643	Knee Lifter Rock Lever Knee Plate with 350231C, for 228368
228365	16643	Knee Lifter Rock Lever Rod, for 228368
228367	16643	" " " Stop Stud, for 228361
228368	16643	Knee Lifter complete, Nos. 228361, 228362, 228364, 228365 and 228369
228369	16643	Knee Lifter Rock Lever Knee Plate Arm, for 228368
228386	16643	Knee Lifter Rock Lever Spring, for 228361
231337	16630	Cloth Guide
*235099	-----	Bobbin Case, for 235100
235100	16625	Bobbin Case complete, Nos. 200594C, 200984C, 202056, 203214, 203216, 203473, 203474, 203648, 235099, 241674, 241675 and two 350405C, for 240211
235576	16629	Tension Release Lever Rod
236060	16620	" Disc Position Pin, for 240023
237174	16620	Thread Controller Spring, for 240446
237202	16624	Balance Wheel (disc) 5-1/4 in. diam., (belt groove 2-3/4 in. diam.) with 200328C and 200335C
237529	16633	Hook Driving Shaft Bushing (front)
237836	16630	Presser Bar Spring (flat)
237837	16630	Knee Lifter Connection Lever
237845	16630	Thread Lubricator Oil Pad Holder, for 237846
237846	16630	Thread Lubricator complete, Nos. 214838, 237845, 240439, 241755, 241758 and 241759
240003	16630	Bed Slide (back)
240004	16630	" " (front)

## NUMERICAL LIST OF PARTS

No.	Plate	Name
240023	16620	Tension Bracket with 201224B and 236060, for 240446
240034	16620	Thread Retainer Nos.240112 to 240114,for 240144
240112	16631	Feed Dog,40 needle hole,for needle sizes 20 and 22
240113	16631	Feed Dog,46 needle hole,for needle sizes 16 and 18
240114	16631	Feed Dog,50 needle hole,for needle sizes 14 and 15 Nos.240115 to 240117,for 240145
240115	16631	Feed Dog,50 needle hole,for needle sizes 14 and 15
240116	16627	Feed Dog,46 needle hole,for needle sizes 16 and 18
240117	16631	Feed Dog,40 needle hole,for needle sizes 20 and 22
240118	16631	Feed Dog,46 needle hole,for needle sizes 16 and 18,for 240143
240125	16246	Lifting Bell Crank Link
240126	16246	" Eccentric Connection
240128	16632	" Presser Foot,for closing gloves, for 240150 to 240152
240130	16632	Lifting Presser Foot,for cording and general upholstery,for 240154
240132	16632	Lifting Presser Foot,for 240156
240133	16629	" " " " 240153
240134	16632	" " " " 240157
240135	16632	" " " " cording and general upholstery,for 240158
240136	16246	Lifting Rock Shaft with 201524E and 350172C
240137	16628	Needle Bar Crank 202692 with 202399, 202400,202552,208552 and 240139
240139	16628	Take-up Lever,for 240137
240141	16629	Tension Release Slide
240142	16629	" " " Spring
240143	16631	Throat Plate,for 240118
240144	16631	" " " 240112 to 240114
240145	16630	" " " 240115 to 240117 Nos.240150 to 240152,for 240128
240150	16632	Vibrating Presser Foot,38 needle hole, with 201015F,for closing gloves
240151	16632	Vibrating Presser Foot,50 needle hole, with 201015F
240152	16632	Vibrating Presser Foot,46 needle hole, with 201015F
240153	16629	Vibrating Presser Foot,40 needle hole, with 201015F,for 240133

## NUMERICAL LIST OF PARTS

No.	Plate	Name
240154	16632	Vibrating Presser Foot,40 needle hole, with 201015F,for 240130
240156	16632	Vibrating Presser Foot,46 needle hole, with 201015F,for 240132
240157	16632	Vibrating Presser Foot,40 needle hole, with 201015F,for 240134
240158	16632	Vibrating Presser Foot,40 needle hole, with 201015F,for 240135
240160	16246	Lifting Eccentric with 200382C and 200398C
*240162	-----	Hook (sewing),for 240163
240163	16625	" 240162 with 203525,224025 two each 200590H and 201253F,for 240211
240165	16626	Hook Saddle complete,Nos.200118D,200364C, 223623,224004,224005,224022,224024, 240167,240211 and 265088
240167	16626	Hook Driving Pinion (spiral) with 200382C and 201220C,for 240165
240170	16628	Needle Bar Thread Guide,for 240219
240171	16246	Lifting Eccentric Connection Crank with 200029E and 248821
240174	16246	Lifting Rock Shaft Bushing
240175	16630	Knee Lifter Lifting Lever
240179	16630	Face Plate with 201650H and 350432XC
240183	16629	Vibrating Presser Bar
240184	16629	" " " Connecting Link
240185	16629	" " " Extension with 204264 and 240186
240186	16629	Vibrating Presser Bar Extension Collar, for 240185
240188	16629	Vibrating Presser Bar Spring
240205	16629	Lifting Bell Crank
240211	16625	Hook and Bobbin Case complete,Nos.235100 and 240163,for 240165
240219	16628	Needle Bar with 200125F,200175D and 240170
*240222	-----	Bed
240223	16627	Feed Bar,for 240224
240224	16627	" " 240223 with 224052,225837 and 350197E,for 240233
240225	16633	Feed Driving Connection with 240226 and 240227
240226	16633	Feed Driving Connection Oiling Felt,for 240225
240227	16633	Feed Driving Connection Oiling Felt Retaining Wire,for 240225
240228	16627	Feed Driving Crank with 200019E
240229	16633	" " Eccentric



No.	Plate	Name
240230	16633	Feed Driving Eccentric Adjusting Disc
240231	16633	" " " Friction Gib
240232	16633	" " Flange with 200333C, 200346C, two each 200369C and 350101C
240233	16627	Feed Driving Rock Shaft 227650 with 201518E, 240224 and 350393C
240235	16633	Feed Regulating Stud
240241	16633	Hook Driving Shaft
240243	16633	" Saddle Bearing
240244	16633	" Driving Shaft Lock Stud
240245	16633	Feed Regulating Stud Retaining Spring
240245	16633	Hook Driving Shaft Lock Stud Retaining Spring
240439	16630	Thread Lubricator Oil Pad Retainer, for 237846
240446	16620	Tension Bracket complete, Nos. 200978H, 201199F, 204271, 223478, 223703, 223704, 223706, 237174, 240023, two each 200309E, 201572B and 244048
*240501	-----	Arm with 202135
240502	16624	" Shaft with 224392 and 350431E
240508	16628	Needle Bar Rock Frame
240802	16624	Arm Shaft Bushing (back) with 202244
241360	16620	Thread Controller Spring Stop
241535	16629	Presser Bar Bushing
241674	16625	Bobbin Case Oiling Felt, for 235100
241675	16625	" " " " Retainer, for 235100
241755	16630	Thread Lubricator Oil Pad (felt), for 237846
241758	16630	Thread Lubricator Oil Reservoir, for 237846
241759	16630	Thread Lubricator Oil Wick, for 237846
244048	16620	Tension Disc, for 240446
248415	16633	Feed Driving Eccentric Adjusting Disc Spring
248416	16633	Feed Driving Eccentric Adjusting Disc Spring Collar with two 200382C
248425	16633	Feed Regulating Stud Spring
248425	16633	Hook Driving Shaft Lock Stud Spring
248437	16628	Needle Bar Rock Frame Hinge Stud
248449	16604	Feed Indicating Disc with 200958C
248821	16246	Lifting Eccentric Connection Crank Oil Packing (wick), for 240171
255168	16633	Bed Oil Cup Nos. 259428 to 259430, for 259431
259428	16615	Bobbin Winder Brake (leather)
259429	16615	" " " Clamp

No.	Plate	Name
259430	16615	Bobbin Winder and Tension Bracket Base
259431	16615	Universal Bobbin Winder complete, Nos. 200056E, 200082D, 200113F, 200299H, 202478 225368, 225381, 225444, 225453 to 225456, 225458, 225462, 228026, 259428 to 259430, two each 225459 and wood screws 3/4 in., No. 12, R.H.B.
263096	16624	Arm Shaft Bushing (front) with 225847
264718	16628	Needle Bar Connecting Link Oil Guard
265032	16633	Safety Clutch Hook Driving Shaft Position Collar with two 201254C, for 265104 Nos. 265050 to 265052, for 265104
265050	16633	Safety Clutch Locking Lever Connecting Link
265051	16633	Safety Clutch Throw-in Latch Spring
265052	16633	" " " " Pin
265057	16633	" " " " for 265104
265088	16626	Bobbin Case Opener Lever Hinge Stud with 202277, for 240165 Nos. 265101 to 265103, for 265104
265101	16633	Safety Clutch Locking Lever
265102	16633	" " " " Spring
265103	16633	" " Pulley with 202253
265104	16633	Safety Clutch complete, Nos. 265032, 265050 to 265052, 265057, 265101 to 265103, 350433C and 350436C
265314	16633	Hook Driving Shaft Lock Ratchet with 200354C and 200362C
350101C	16633	Feed Driving Eccentric Friction Gib Ad- justing Screw Set Screw, for 240232
350172C	16246	Lifting Bell Crank Link Screw Stud, for 240136
350197E	16627	Feed Lifting Cam Fork Screw, for 240224
350231C	16643	Knee Lifter Rock Lever Extension Set Screw for 228359
350231C	16643	Knee Lifter Rock Lever Knee Plate Arm Set Screw, for 228359
350231C	16643	Knee Lifter Rock Lever Knee Plate Set Screw, for 228364
350299C	16629	Vibrating Presser Bar Thumb Screw (pres- sure regulating)
350393C	16627	Feed Bar Hinge Screw (driving), for 240233
350405C	16625	Bobbin Case Oiling Felt Retainer Screw, for 235100
350419H	16624	Balance Wheel Adjusting Screw
350431E	16624	Arm Shaft Oil Packing Stop Screw, for 240502
350432XC	16630	Thread Lubricator Screw, for 240179

No.	Plate	Name
350433C	16633	Safety Clutch Locking Lever Hinge Screw, for 265104
350436C	16633	Safety Clutch Locking Lever Spring Screw, for 265104

**SINGER** Needles should be used  
in **SINGER** Machines  
These Needles and their Containers  
are marked with the  
Company's Trade Mark "SIMANCO."<sup>\*\*</sup> 1

Needles in Containers marked  
"FOR SINGER MACHINES"  
are NOT **SINGER** made needles. 2

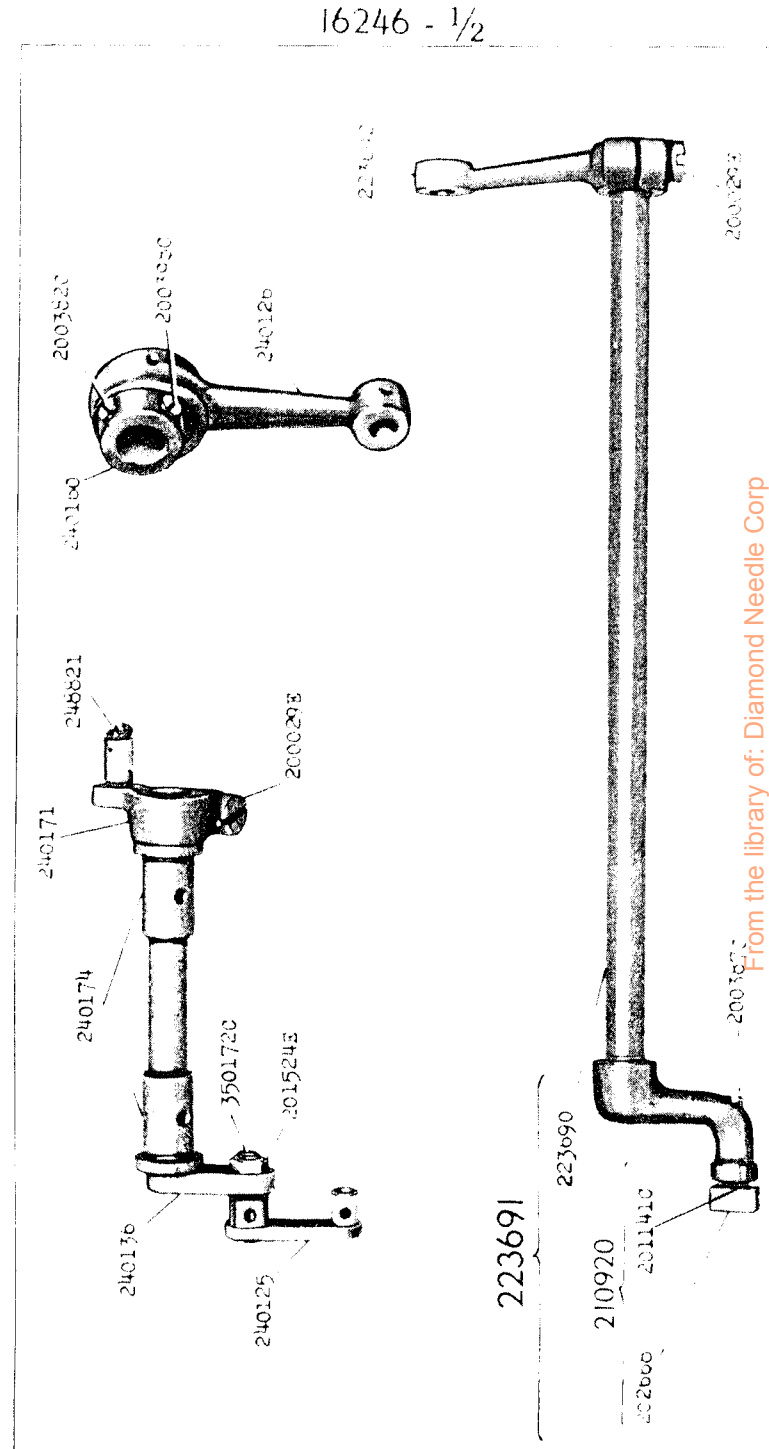

From the library of: Diamond Needle Corp

16604 - 3/8

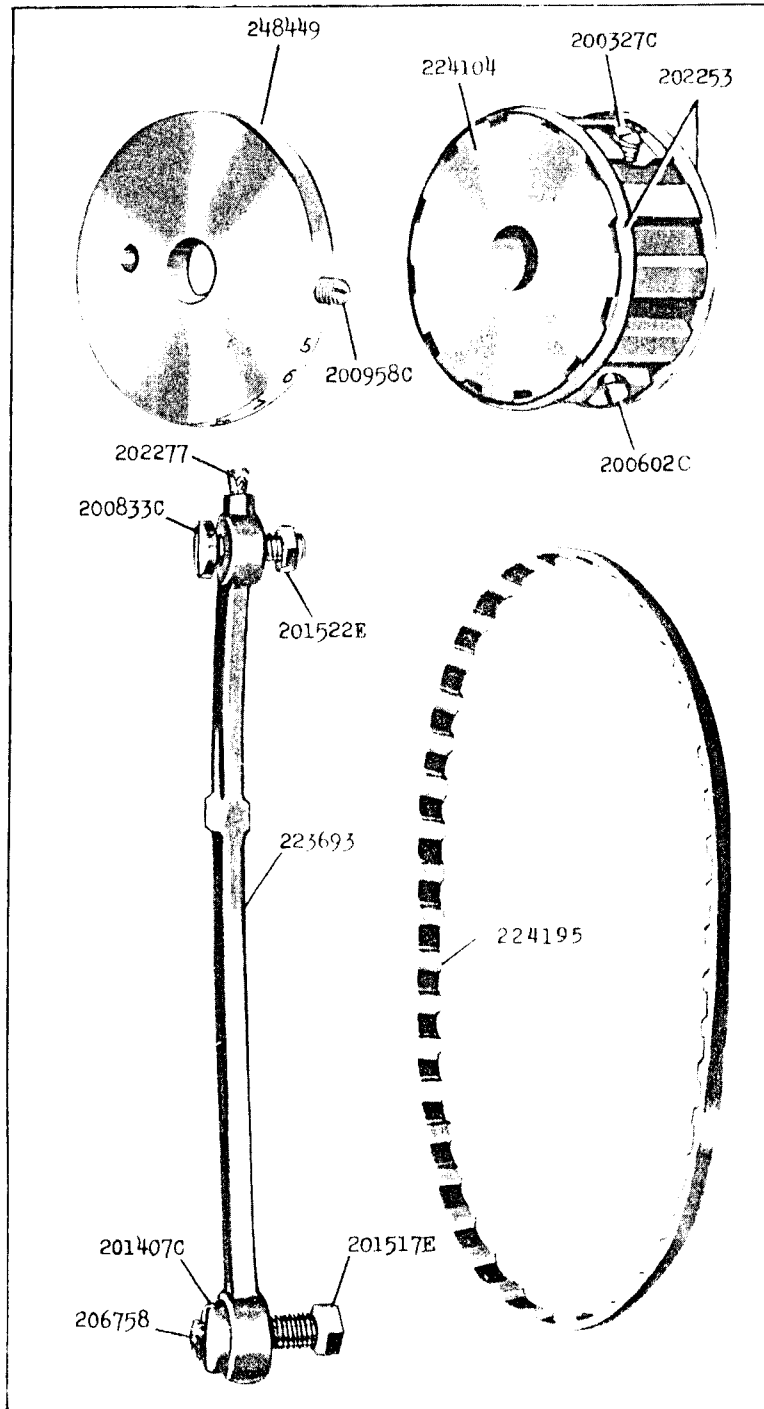

16615 - 1/2

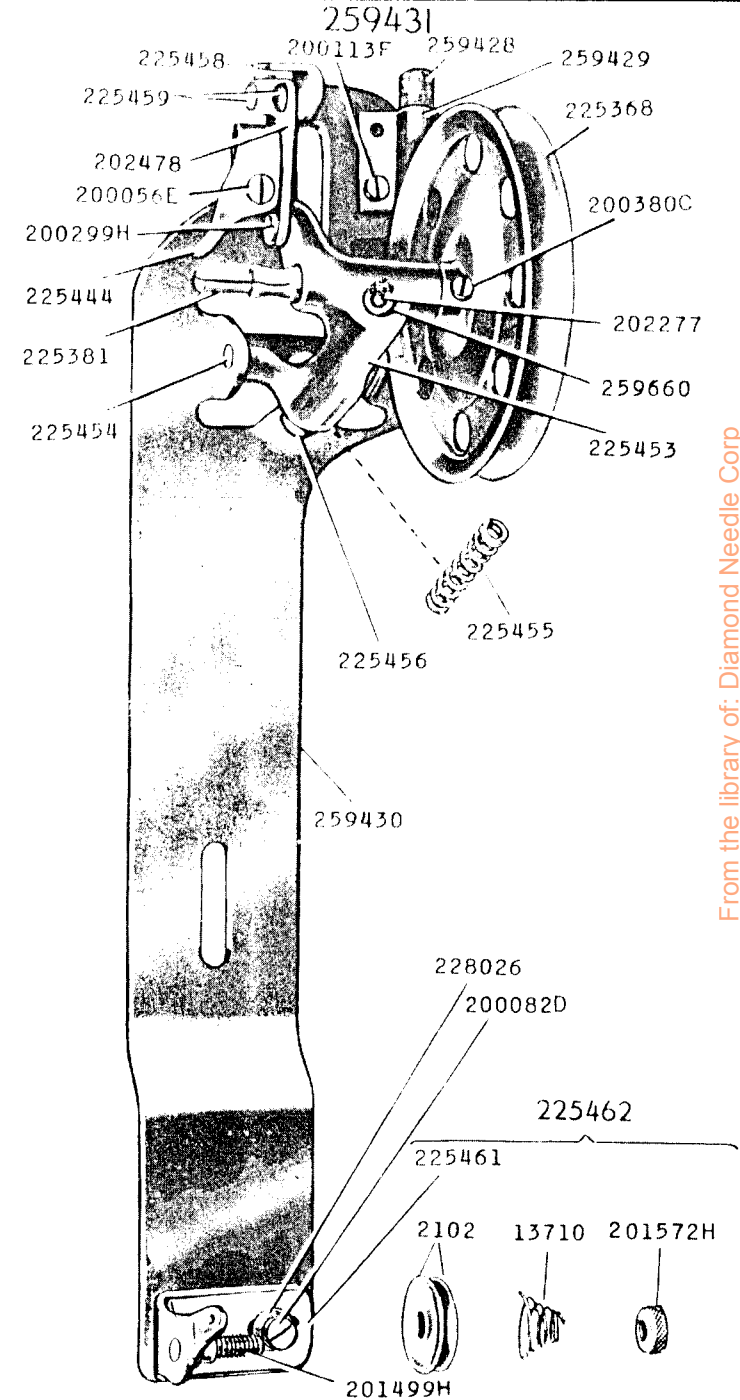

From the library of: Diamond Needle Corp



240211 3-F

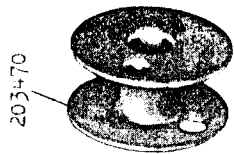
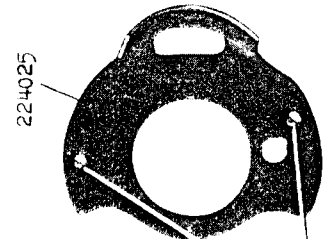
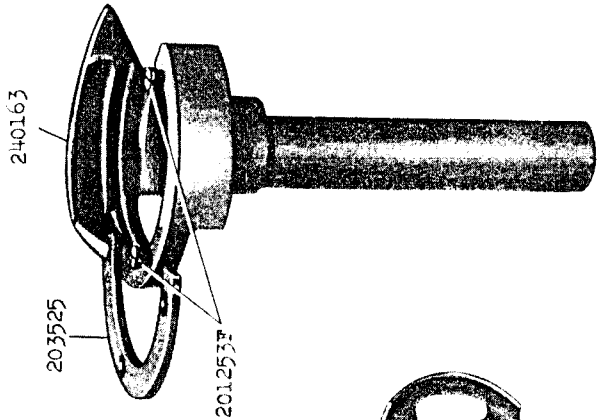
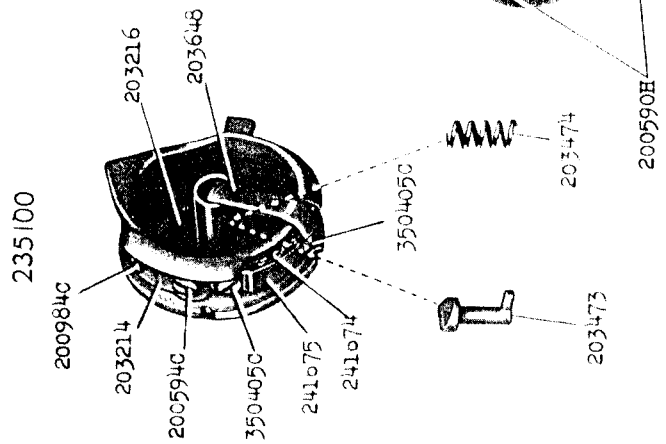

240165

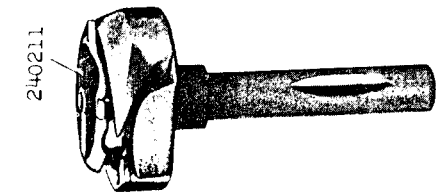

224024

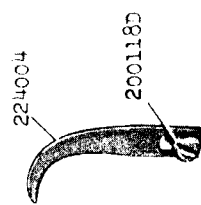
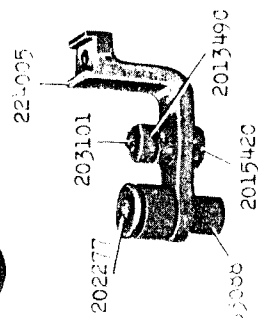
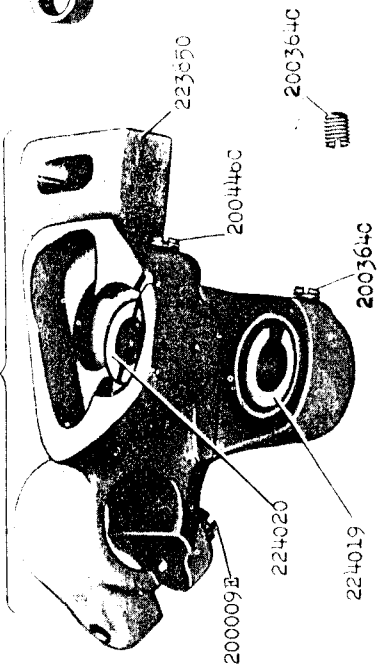

240167

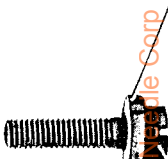

From the library of: Diamond  Corp

225565

16627 - 3/8

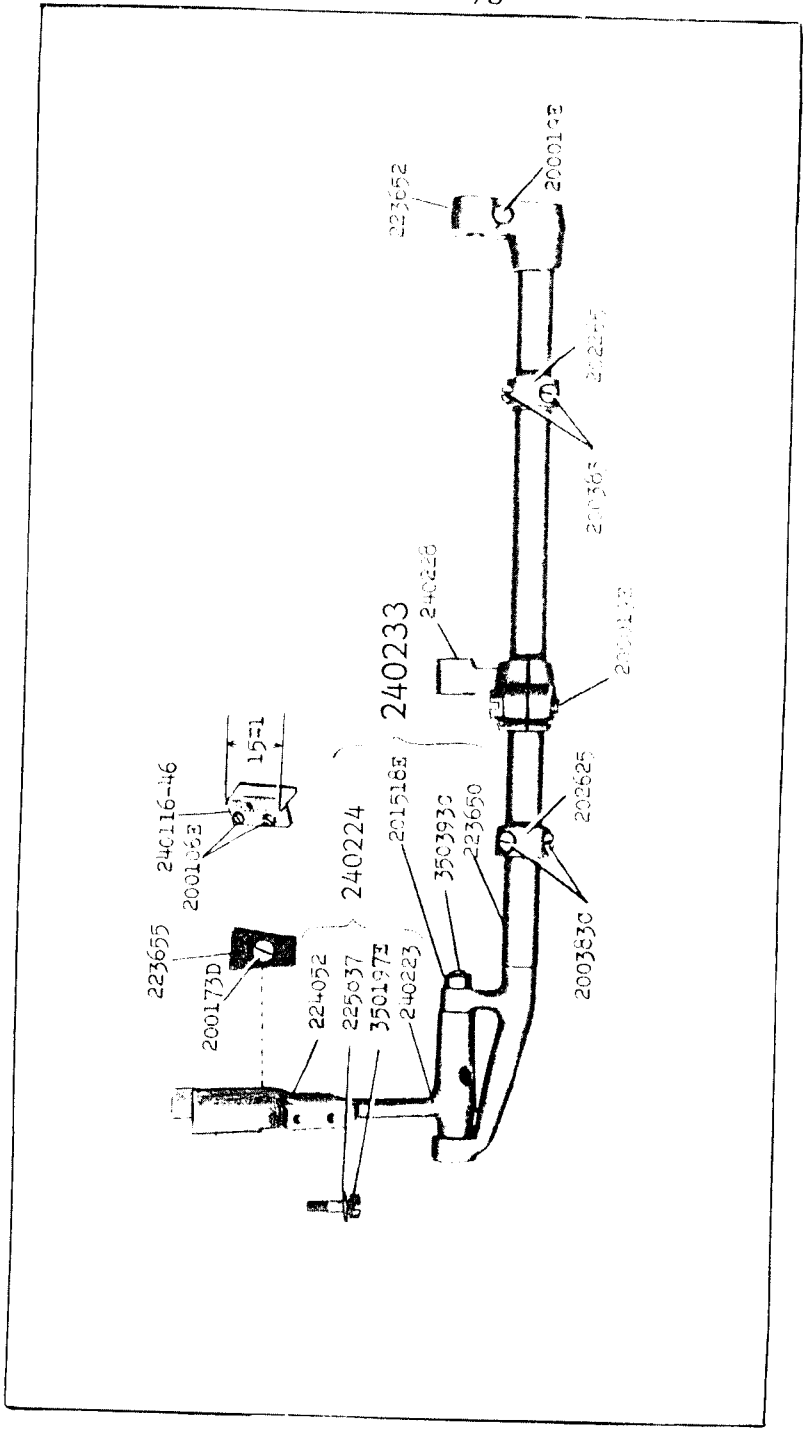

16628 - 1/2

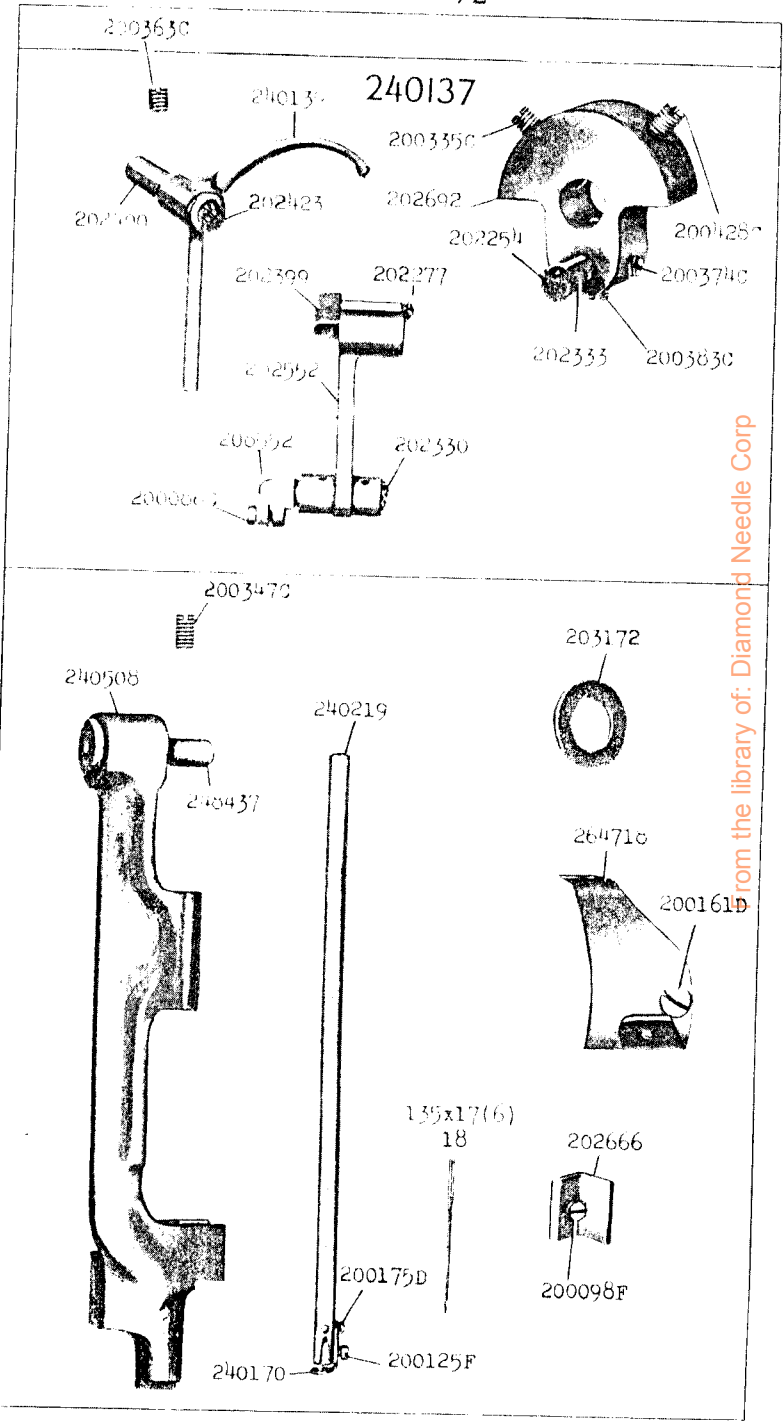

from the library of: Diamond Needle Corp







16633 - 1/3

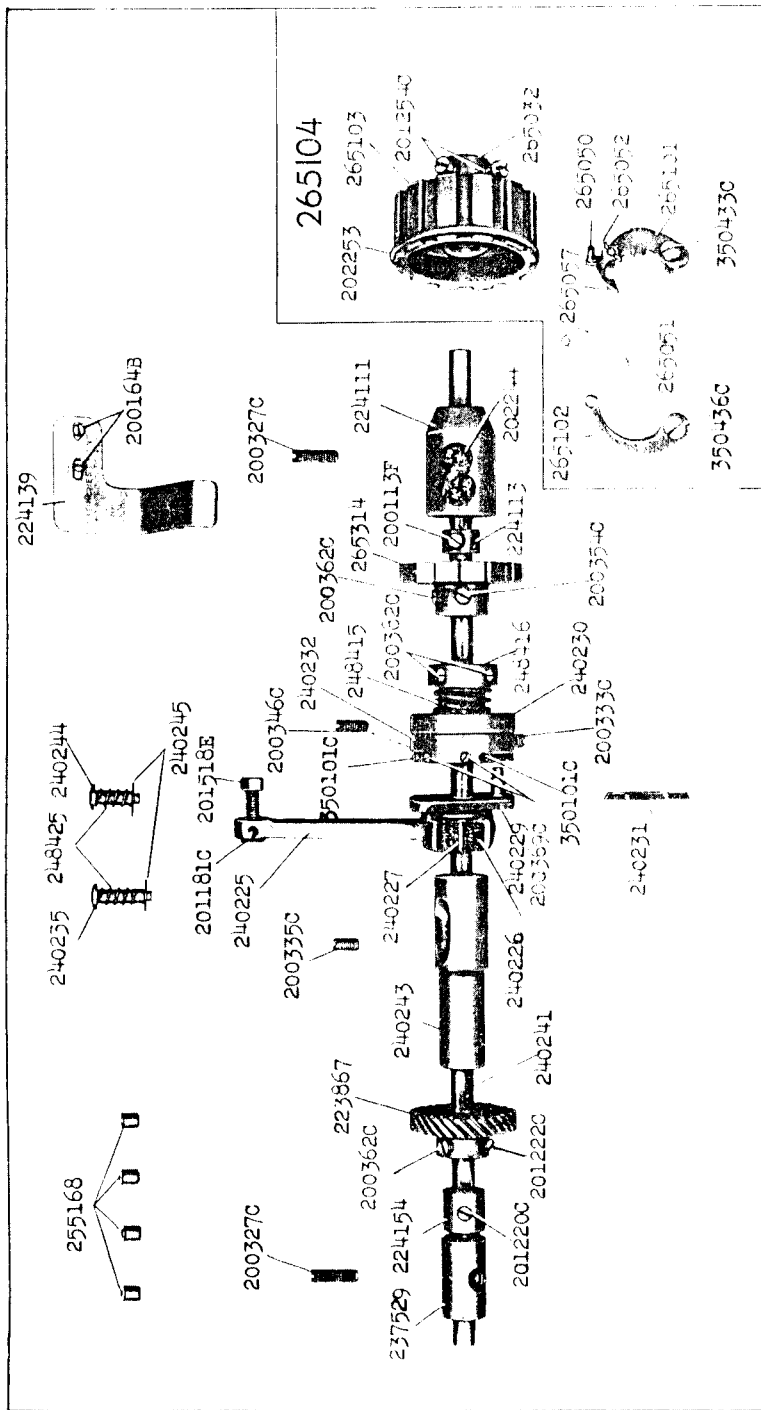

16643 - 3/8

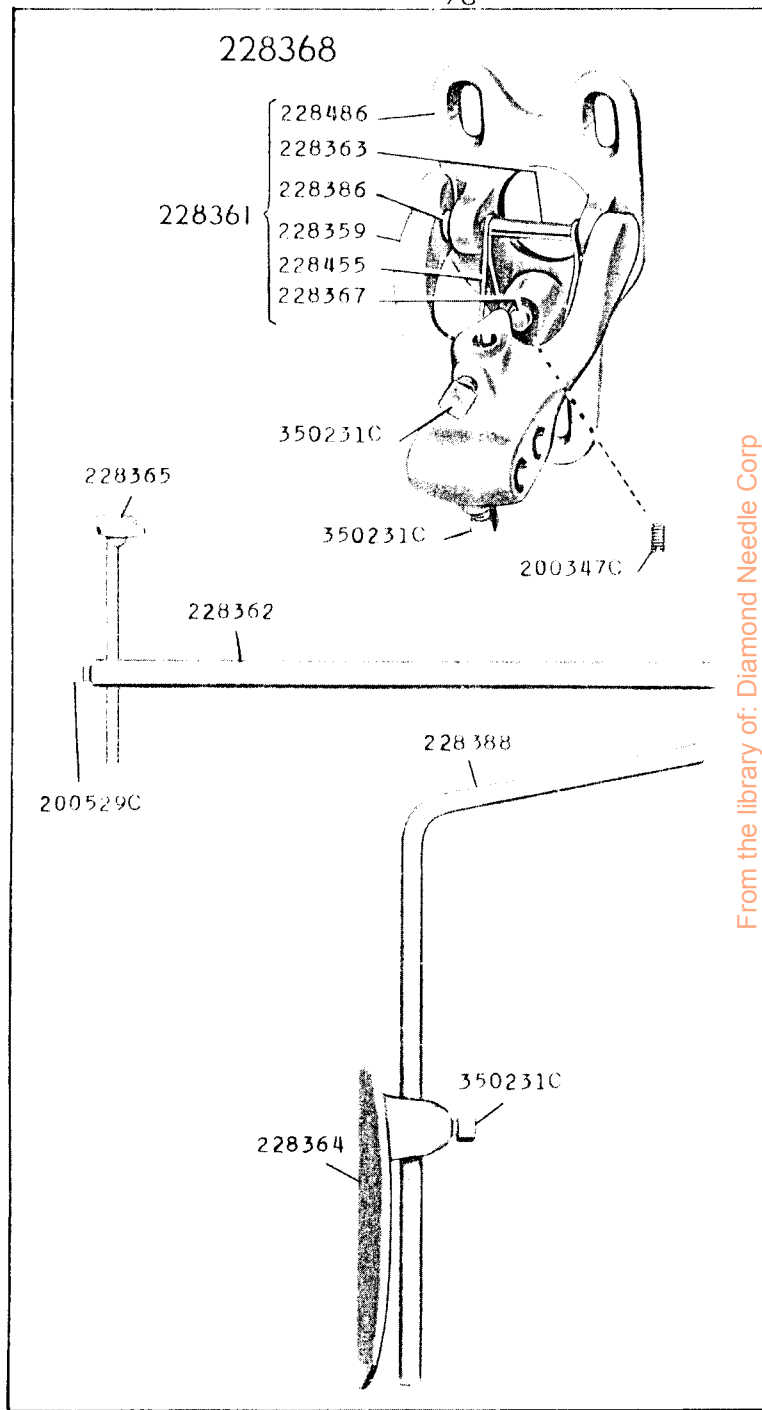

From the library of: Diamond Needle Corp

16644 - 1/3

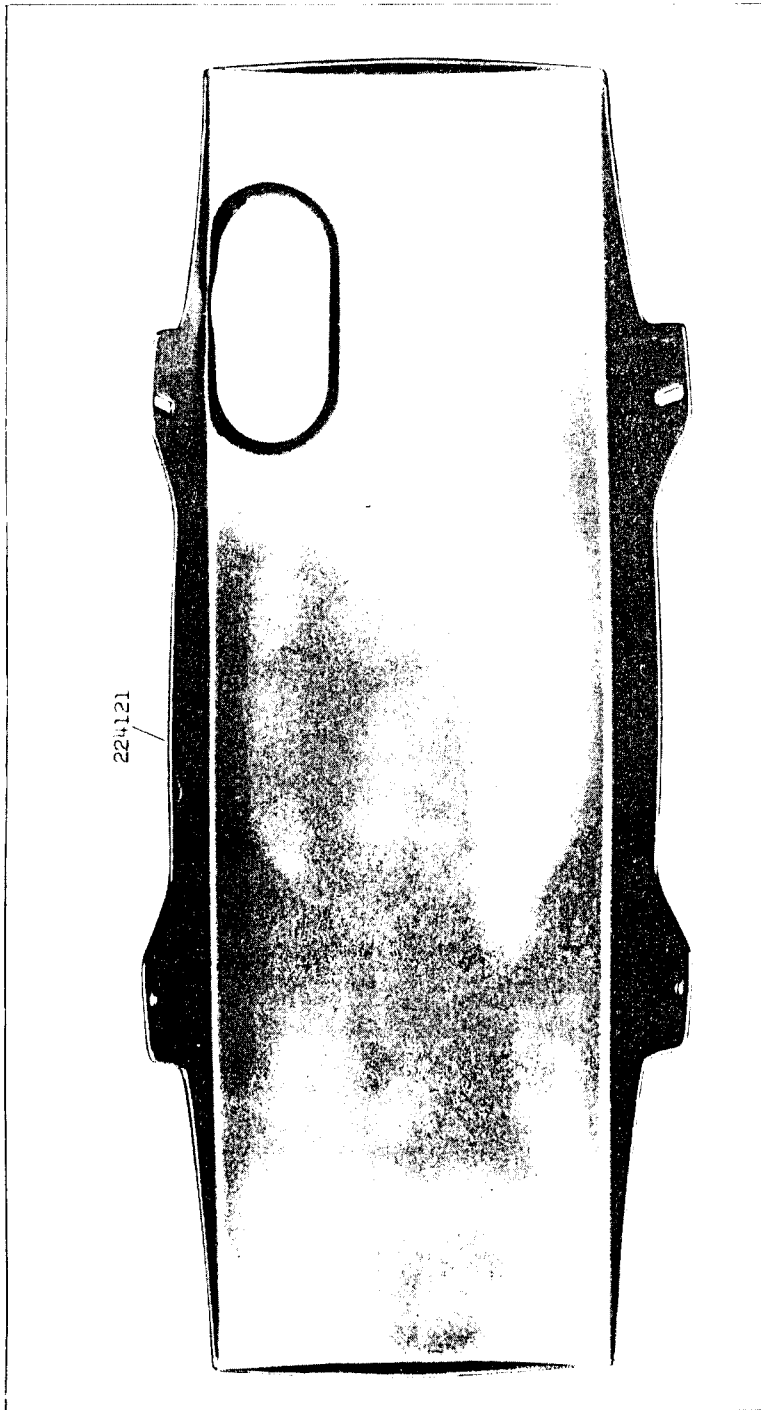

17620 - 1/3

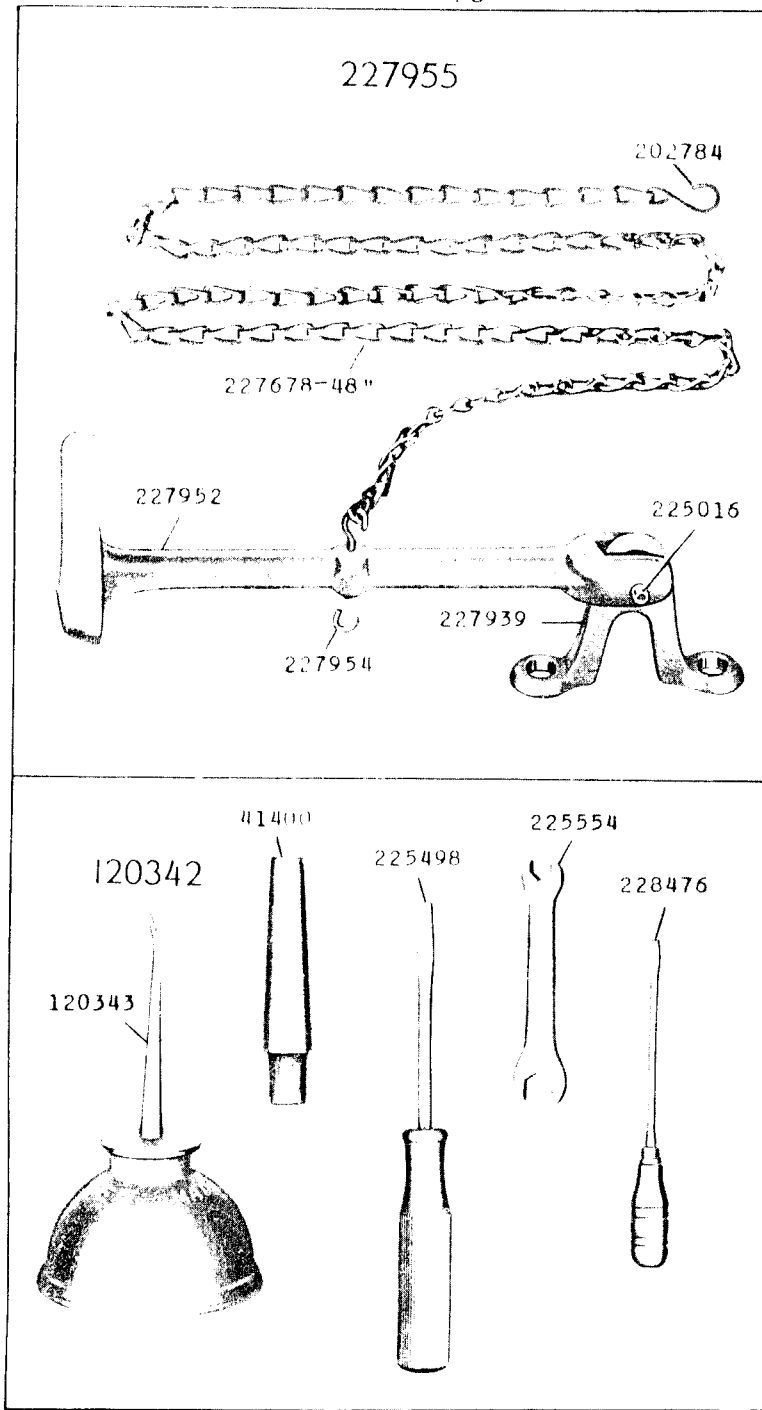

From the library of: Diamond Needle Corp

17900 - 1/6

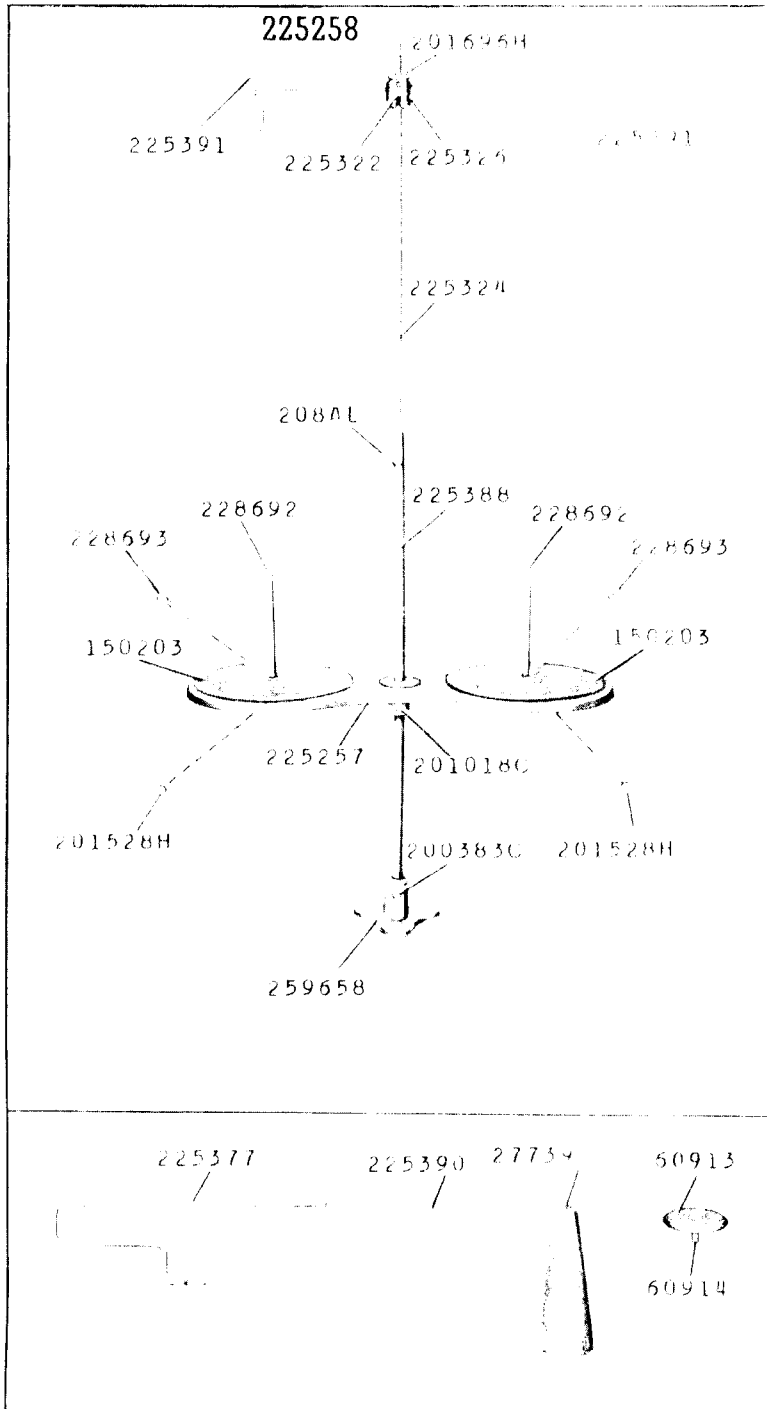

From the library of: Diamond Needle Corp